

Retail Price List - Valid From August 2024

Focussing R&D, marketing and manufacturing at sites across the US, in Denmark and China with over a century of industry experience and leadership, Perlisten Audio offers music and home cinema enthusiasts a completely proprietary path to greater fidelity and value. Perlisten Audio is the first brand in the world to have received THX Dominus Certification, the newest and the largest performance class of THX Certification, designed to bridge the gap between large home theatre speakers and those used in movie houses worldwide.

Signature Series speakers (priced as singles)
RETAIL
ex VAT

RETAIL
inc VAT

MODEL S7t TOWER

Featuring proprietary DPC-Array of 28mm Beryllium dome and dual 28mm TPCD ultra-lightweight domes. All transducers are developed ground up by our engineers. Custom bass drivers made from thin-ply carbon diaphragms (TPCD) can be configured as bass reflex or acoustic suspension and adjusted for listener preference. **World's first loudspeakers to be certified for THX Dominus.**

Enclosure alignment: 4-way bass reflex/acoustic suspension

Driver complement: Flagship DPC Array: 28mm Beryllium, 28mm (2) Textreme TPCD; Woofers: 180mm (4) Textreme TPCD

Sensitivity: 92dB/2.83V/1.0m

Impedance: 4Ω nominal/1.0m

Crossover Frequency: 500Hz, 1.1kHz, 4.4kHz

Frequency Response (+/-2dB): 80-20kHz

Frequency Response (-10dB): Bass reflex: 22-37kHz; Acoustic suspension: 32-37kHz

Dimensions (HxWxD): 1295x240x400mm

Weight: 55.7 kg

Recommended Amplifier Power: 100-600W RMS

SPL capability (100-20kHz): 117dB peak <2%-2nd, 3rd Harmonics

Certification: THX Dominus - large LCR



| | | | | |
|---|--|--|------------------|-------------------|
| S7t High Gloss Ebony | | | £8,750.00 | £10,500.00 |
| S7t High Gloss Black or White | | | £7,500.00 | £9,000.00 |
| Special Edition Finishes: Natural Ebony, High Gloss Walnut, Natural Walnut, Natural Black Cherry | | | £8,750.00 | £10,500.00 |

Retail Price List - Valid From August 2024
Signature Series speakers
RETAIL
ex VAT

RETAIL
inc VAT

MODEL S7c CENTRE
FSimilar driver complement to the flagship S7T. THX Dominus certified.

Enclosure alignment: 4-way acoustic suspension

Driver complement: Flagship DPC Array: 28mm Beryllium, 28mm (2) Textreme TPCD; Woofers: 180mm (4) Textreme TPCD

Sensitivity: 92dB/2.83V/1.0m

Impedance: 4Ω nominal/3.2Ω min

Crossover Frequency: 500Hz, 1.1kHz, 4.4kHz

Frequency Response (+/-2dB): 80-20kHz

Frequency Response (-10dB): 38-37kHz

Typical in room bass extension: 32Hz

Dimensions (HxWxD): 960x240x400mm Weight: 33.5 kg

Recommended Amplifier Power: 100-600W RMS

SPL capability (100-20kHz): 117dB peak <2%-2nd, 3rd Harmonics

Certification: THX Dominus - LCR

High Gloss Ebony
£7,000.00
£8,400.00
High Gloss Black
£6,250.00
£7,500.00
High Gloss White
£6,333.33
£7,600.00
MODEL S5t TOWER
A smaller version of the S7t with nearly the same SPL, sensitivity, and low frequency output.

Enclosure alignment: 3-way bass reflex / acoustic suspension

Driver complement: Flagship DPC-Array: 28mm (1) Beryllium; 28mm (2) Textreme TPCD; Woofers: 180mm(2) Textreme TPCD

Sensitivity: 89.5dB / 2.83v / 1.0m

Impedance: 4Ω nominal / 3.0Ω min

Response Linearity: 80 - 20kHz +/-1.5dB window

Frequency Response (-10dB): Bass reflex: 24 - 32kHz; Acoustic suspension: 36 - 32kHz

Typical In Room bass extension: Bass reflex: 20Hz; Acoustic suspension: 23Hz

Dimensions (HxWxD): 1119 x 240 x 400mm Weight 43.2 kg

Recommended Amplifier Power 100 - 300W RMS

SPL capability @1m (100-20kHz): 114.3dB peak; 114.0dB peak <3% - 2nd, 3rd Harmonics

Certification: THX Dominus, THX Ultra

High Gloss Ebony
£6,833.33
£8,200.00
High Gloss Black
£5,916.67
£7,100.00
High Gloss White
£5,916.67
£7,100.00

Retail Price List - Valid From August 2024
Signature Series speakers
RETAIL
ex VAT

RETAIL
inc VAT

MODEL S5c CENTRE

A world class centre for slightly smaller rooms and screens, similar to the S7c with nearly the same SPL, sensitivity, and low frequency output.

Enclosure alignment: 3-way acoustic suspension

Driver complement: Flagship DPC Array: 28mm (1) Beryllium; 28mm (2) Textreme TPCD

Sensitivity: 88.8dB / 2.83v / 1.0m

Impedance: 4Ω nominal / 3.2Ω min

Response Linearity: 80 - 20kHz +/-1.5dB window

Frequency Response (-10dB): 42 - 34kHz

Typical in room bass extension: 33Hz

Dimensions (HxWxD): 4240 x 596 x 300mm

Weight: 21.4 kg

Recommended Amplifier Power: 100 - 300W RMS

SPL capability @1m (100-20kHz): 113.6dB peak; 111.0dB peak <3% - 2nd, 3rd Harmonics

Certification: THX Dominus, THX Ultra

High Gloss Ebony
£5,375.00
£6,450.00
High Gloss Black
£4,583.33
£5,500.00
High Gloss White
£4,583.33
£5,500.00
MODEL S5m MONITOR

Features Perlisten DPC array and two 180mm Textreme TPCD woofers. THX Dominus certified.

Enclosure alignment: 3-way bass reflex/acoustic suspension

Driver complement: Flagship DPC Array: 28mm Beryllium, 28mm (2) Textreme TPCD; Woofers: 180mm (2) Textreme TPCD

Sensitivity: 89.6dB/2.83V/1.0m

Impedance: 4Ω nominal/3.0 Ω min

Frequency Response (+/-1.5dB): 80-20kHz

Frequency Response (-10dB): Bass reflex: 35-37kHz; Acoustic suspension: 71-37kHz

Typical in room bass extension: Bass reflex: 29Hz; Acoustic suspension: 32Hz

Dimensions (HxWxD) without stand: 600x240x400mm Weight: 19.0 kg

Recommended Amplifier Power: 50-300W RMS

SPL capability (100-20kHz): 117dB peak <2%-2nd, 3rd Harmonics

Certification: THX Dominus; THX Ultra

High Gloss Ebony
£5,750.00
£6,900.00
High Gloss Black or White
£4,916.67
£5,900.00

Retail Price List - Valid From August 2024
Signature Series speakers
RETAIL
ex VAT

RETAIL
inc VAT

MODEL S4b BOOKSHELF

For use in 2.1 systems or as surround, height or LCR in a cinema system using subwoofers. Bookshelf, stand or on-wall mounting with keyhole or available bracket. Features DPC-Array and single 180mm Textreme TPCD woofer. THX Dominus certified.

Enclosure alignment: 3-way acoustic suspension

Driver complement: Flagship DPC Array: 28mm Beryllium, 28mm (2) Textreme TPCD; Woofers: 180mm (1) Textreme TPCD

Sensitivity: 85.4dB / 2.83V / 1.0m

Impedance: 4Ω nominal/3.2Ω min

Frequency Response (+/-1.5dB): 100 - 20kHz

Frequency Response (-10dB): 36 - 37kHz

Typical in room bass extension: 30Hz

Dimensions (HxWxD) without stand: 420 x 240 x 185mm

Weight: 11.0 kg

Recommended Amplifier Power: 50 - 300W RMS

SPL capability (100-20kHz): 111dB peak <2% - 2nd, 3rd Harmonics

Certification: THX Dominus

High Gloss Ebony
£3,583.33
£4,300.00
High Gloss Black or White
£2,916.67
£3,500.00
MODEL S4s SURROUND

Designed for on-wall or flushed-in (2pi) applications as surround, height or LCR. High sensitivity, power handling and low distortion make S4s the ideal choice as a surround speaker for high-end cinemas. Features DPC-Array and single single 180mm Textreme TPCD woofer. THX Dominus certified.

Enclosure alignment: 3-way acoustic suspension

Driver complement: Flagship DPC Array: 28mm Beryllium, 28mm (2) Textreme TPCD; Woofers: 180mm (1) Textreme TPCD

Sensitivity: 89.6dB/2.83V/1.0m

Impedance: 4Ω nominal/3.2Ω min

Frequency Response (+/-1.5dB): 100 - 20kHz

Frequency Response (-10dB): 39 - 37kHz

Typical in room bass extension: 33Hz

Dimensions (HxWxD) without stand: 405x240x185mm

Weight: 9.5 kg

Recommended Amplifier Power: 50 - 300W RMS

SPL capability (100-20kHz): 111dB peak <2% - 2nd, 3rd Harmonics

Certification: THX Dominus; THX Ultra

High Gloss Ebony
£3,333.33
£4,000.00
High Gloss Black or White
£2,750.00
£3,300.00

Retail Price List - Valid From August 2024
Dominus certified in-wall speaker
RETAIL
ex VAT

RETAIL
inc VAT

Perlisten S7i-LR
The award-winning flagship S7t design adapted for THX Dominus Certified in-wall applications.

Enclosure Alignment: 4-way acoustic suspension

Driver complement: DPC Array: 28mm Beryllium, 28mm (2) Textreme TPCD; Woofers: 180mm (4) Textreme TPCD

Sensitivity: 91.9dB / 2.83V / 1.0m

Impedance: 4Ω nominal / 3.4Ω min

Response Linearity: 80 - 20kHz +/-1.5dB window

Frequency Response (-10dB): 45 - 37kHz

Typical In Room bass extension: 37Hz

Dimensions (HxWxD): 1036.6 x 298.6 x 111.2mm

Mounting Dimensions (HxWxD): 996 x 257 x 101.7mm

Weight: 26.4 kg

Recommended Amplifier Power: 100 - 600W RMS

SPL capability @1m (100-20kHz): 119.7dB peak; 117.0dB peak <3% 2nd, 3rd Harmonics

Certification: THX Dominus

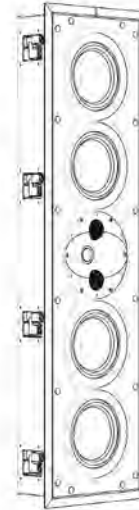
S7i-LR
£6,208.33
£7,450.00
Perlisten S7i-C
The award-winning flagship S7t design adapted for THX Dominus Certified in-wall centre-channel applications.

Enclosure Alignment: 4-way acoustic suspension

Driver complement: DPC Array: 28mm Beryllium, 28mm (2) Textreme TPCD; Woofers: 180mm (4) Textreme TPCD

Sensitivity: 92.0dB / 2.83V / 1.0m

Impedance: 4Ω nominal / 3.4Ω min

Response Linearity: 80 - 20kHz +/-1.5dB window

Frequency Response (-10dB): 45 - 37kHz

Typical In Room bass extension: 39Hz

Dimensions (HxWxD): 298.6 x 1036.6 x 111.2mm

Mounting Dimensions (HxWxD): 257 x 996 x 101.7mm

Weight: 26.4 kg

Recommended Amplifier Power: 100 - 600W RMS

SPL capability @1m (100-20kHz): 119.8dB peak; 117.0dB peak <3% 2nd, 3rd Harmonics

Certification: THX Dominus

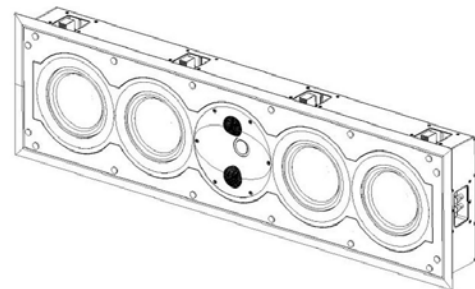

S7i-C
£6,208.33
£7,450.00

Retail Price List - Valid From August 2024
Dominus certified in-wall speaker
RETAIL
ex VAT

RETAIL
inc VAT

Perlisten S5i-LR
The award-winning S5m design adapted for THX Dominus Certified in-wall applications.

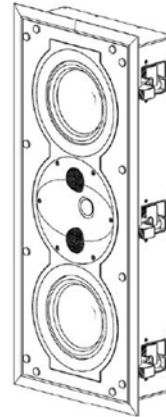
Enclosure Alignment: 3-way acoustic suspension
 Driver complement: DPC Array: 28mm Beryllium, 28mm (2) Textreme TPCD; Woofers: 180mm (2) Textreme TPCD
 Sensitivity: 91.9dB / 2.83V / 1.0m
 Impedance: 4Ω nominal / 3.4Ω min
 Response Linearity: 80 - 20kHz +/-1.5dB window
 Frequency Response (-10dB): 52 - 37kHz
 Typical In Room bass extension: 46Hz
 Dimensions (HxWxD): 624 x 257 x 101.7mm
 Mounting Dimensions (HxWxD): 624 x 257 x 101.7mm
 Weight: 15.9 kg
 Recommended Amplifier Power: 100 - 350W RMS
 SPL capability @1m (100-20kHz): 117.3dB peak; 117.0dB peak <3% 2nd, 3rd Harmonics
 Certification: THX Dominus

S5i-LR
£5,250.00
£6,300.00
Perlisten S5i-C
The award-winning S5m design adapted for THX Dominus Certified in-wall centre channel applications.

Enclosure Alignment: 3-way acoustic suspension
 Driver complement: DPC Array: 28mm Beryllium, 28mm (2) Textreme TPCD; Woofers: 180mm (2) Textreme TPCD
 Sensitivity: 91.6dB / 2.83V / 1.0m
 Impedance: 4Ω nominal / 3.4Ω min
 Response Linearity: 80 - 20kHz +/-1.5dB window
 Frequency Response (-10dB): 50 - 37kHz
 Typical In Room bass extension: 42Hz
 Dimensions (HxWxD): 298 x 665 x 111mm
 Mounting Dimensions (HxWxD): 257 x 624 x 101.7mm
 Weight: 15.9 kg
 Recommended Amplifier Power: 100 - 350W RMS
 SPL capability @1m (100-20kHz): 117.0dB peak; 117.0dB peak <3% 2nd, 3rd Harmonics
 Certification: THX Dominus

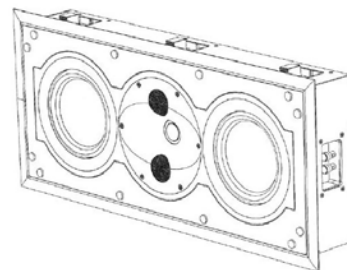
S5i-C
£5,250.00
£6,300.00

Retail Price List - Valid From August 2024

Dominus certified in-wall speaker

RETAIL
ex VAT

RETAIL
inc VAT

Perlisten S4i-LCRS

The award-winning S4s/S4b designs adapted for THX Dominus Certified in-wall surround channel applications.



Enclosure Alignment: 3-way acoustic suspension
 Driver complement: DPC Array: 28mm Beryllium, 28mm (2) Textreme TPCD; Woofers: 180mm (1) Textreme TPCD
 Sensitivity: 88.0dB / 2.83V / 1.0m
 Impedance: 4Ω nominal / 3.4Ω min
 Response Linearity: 80 - 20kHz +/-1.5dB window
 Frequency Response (-10dB): 42 - 37kHz
 Typical In Room bass extension: 38Hz
 Dimensions (HxWxD): 479 x 298 x 111mm
 Mounting Dimensions (HxWxD): 438 x 257 x 101.7mm
 Weight: 11.2 kg
 Recommended Amplifier Power: 50 - 250W RMS
 SPL capability @1m (100-20kHz): 112.0dB peak; 111.0dB peak <3% 2nd, 3rd Harmonics
 Certification: THX Dominus Surround, Ultra LCR

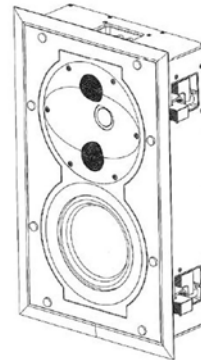

| | | | | |
|--|--|--|------------------|-------------------|
| S4i-LCRS | | | £3,125.00 | £3,750.00 |
| On-Wall Adaptor Frames for In-Wall speakers | | | RETAIL ex VAT | RETAIL inc VAT |
| 7i OWF MW | on wall frame Matt White for 7 series | | £416.67 | £500.00 |
| 5i OWF MW | on wall frame Matt White for 5 series | | £333.33 | £400.00 |
| 4i OWF MW | on wall frame: Matt White for 4 series | | £250.00 | £300.00 |



On-Wall Frame for In-Walls

Retail Price List - Valid From August 2024
Dominus/Ultra certified in-ceiling speakers
RETAIL
ex VAT

RETAIL
inc VAT

S3ic In-Ceiling

A perfect solution for high-end Dolby Atmos, DTS-X and Auro-3D applications, and extremely versatile as LCR, surround, height or wide channel speaker, the S3ic is optimised for in-ceiling applications where a 30 degree reference axis within a larger listening window is desired.

Perlisten S3ic specifications

Enclosure Alignment: 3-way acoustic suspension

Driver complement: DPC Array: 28mm Beryllium tweeter; 28mm Textreme TPCD mid woofers;

165mm Alum frame, Textreme TPCD

Sensitivity: 89.7dB / 2.83v / 1.0m

Impedance: 4 Ω nominal / 3.2 Ω min

Listening Window (from 30deg Ref): Horizontal: +/-55 deg; Vertical: +/-30 deg

Response Linearity: 100 - 20kHz +/-1.5dB window

Frequency Response: 57 - 30kHz (-6dB); 43 - 33kHz (-10dB)

Typical In Room bass extension: 48Hz (-6dB); 31Hz (-10dB)

Overall Dimensions (with grille) mm: 343.3 dia x 194.8 depth

Recommended cutout: 305mm diameter

Weight: 9.4kg

Recommended Amplifier Power: 50 - 250W (with 80Hz HPF); 50 - 150W (full range)

SPL capability @1m (100-20kHz): 113.7dB peak; 111.0dB peak <3% 2nd, 3rd Harmonics

Certification: THX Dominus, THX Ultra

s3i in ceiling
£2,833.33
£3,400.00



Retail Price List - Valid From August 2024
Reference Series speakers (priced as singles)
RETAIL
ex VAT

RETAIL
inc VAT

MODEL R7t TOWER

Two-channel high fidelity speaker with the versatility to be used in multi-channel systems. Featuring DPC-Array of three 26mm silk domes and twin 165mm HFP woofers, which can be aligned as bass reflex or acoustic suspension depending on specific tastes. THX Dominus certified.

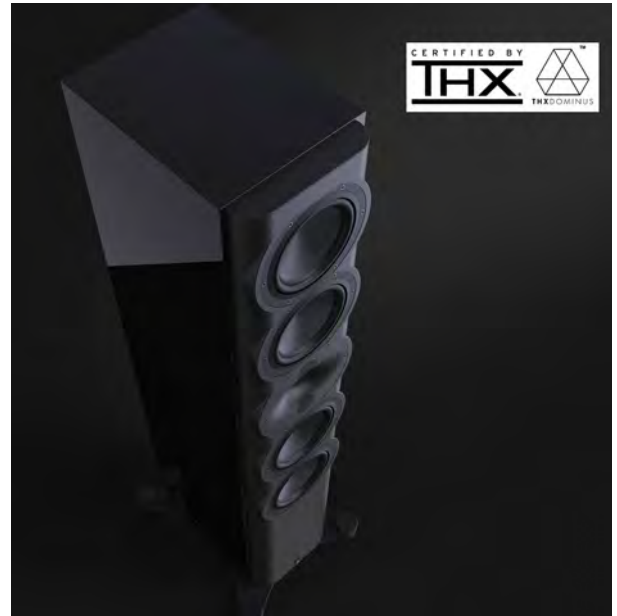
Enclosure Alignment: 4-way bass reflex / acoustic suspension
 Driver complement: DPC-Array: 26mm(3) Silk dome, woofers: 165mm (4) HPF diaphragms
 Sensitivity: 90.0dB/2.83V/1.0m
 Impedance: 4Ω nominal/3.1Ω min
 Response Linearity 80 - 20kHz +/-1.5dB
 Frequency Response (-10dB): Bass reflex: 27 - 32kHz; Acoustic suspension: 38 - 32kHz
 Typical In Room bass extension: bass reflex: 19Hz; acoustic suspension: 30Hz
 Dimensions (HxWxD): 1268 x 230 x 350mm Weight: 48.0 kg
 Recommended Amplifier Power: 100 - 400W RMS
 SPL capability @1m (100-20kHz): 116.0dB peak <3% - 2nd, 3rd Harmonics
 Certification: THX Dominus; THX Ultra

R7t High Gloss Black or White
£3,666.67
£4,400.00
MODEL R5t TOWER

Two-channel high fidelity speaker with the versatility to be used in multi-channel systems. Featuring DPC-Array of three 26mm silk domes and twin 165mm HFP woofers, which can be aligned as bass reflex or acoustic suspension depending on specific tastes. THX Dominus certified.

Enclosure alignment: 3-way bass reflex / acoustic suspension
 Driver complement: DPC Array: 26mm(3) Silk dome, woofers: 165mm (2) HPF diaphragms
 Sensitivity: 89dB/2.83V/1.0m
 Impedance: 4Ω nominal/3.2Ω min
 Crossover Frequency: 1.25Hz, 4.4kHz
 Frequency Response (+/-2dB): 80 - 20kHz
 Frequency Response (-10dB): Bass reflex: 24 - 32kHz; Acoustic suspension: 38 - 32kHz
 Typical in room bass extension: Bass reflex: 21Hz; Acoustic suspension: 32Hz
 Dimensions (HxWxD): 1100x230x350mm Weight: 26.5 kg
 Recommended Amplifier Power: 100-250W RMS
 SPL capability (100-20kHz): 111dB peak <2%-2nd, 3rd Harmonics
 Certification: THX Dominus; THX Ultra

R5t High Gloss Black or White
£2,875.00
£3,450.00

Retail Price List - Valid From August 2024
Reference Series speakers
RETAIL
ex VAT

RETAIL
inc VAT

MODEL R5c CENTRE

Designed to be mounted on optional stand, or wall mounted using dedicated tilt/swivel bracket. Featuring DPC-Array of three 26mm silk domes and twin 165mm HFP woofers. THX Dominus certified.

Enclosure Alignment: 3-way acoustic suspension

Driver compliment: DPC-Array: 26mm (3) Silk dome, woofers: 165mm(2) HPF diaphragms

Sensitivity: 88.6dB/2.83V/1.0m

Impedance: 4Ω nominal / 3.4Ω min

Response Linearity: 80 - 20kHz +/-1.5dB

Frequency Response (-10dB): 49 - 32kHz

Typical In Room bass extension: 44Hz

Dimensions (HxWxD): 240 x 550 x 270mm

Weight: 15.0 kg

Recommended Amplifier Power: 100 - 250W RMS

SPL capability @1m (100-20kHz): 112.6dB peak <3% - 2nd, 3rd Harmonics

Certification: THX Dominus, THX Ultra

R5c High Gloss Black or White
£2,000.00
£2,400.00
MODEL R5m MONITOR

Designed to be mounted on optional stand, or wall mounted using dedicated tilt/swivel bracket. Featuring DPC-Array of three 26mm silk domes and twin 165mm HFP woofers. THX Dominus certified.

Enclosure Alignment: 3-way bass reflex / acoustic suspension

Driver compliment: DPC-Array: 26mm (3) Silk dome, woofers: 165mm (2) HPF diaphragms

Sensitivity: 89.2dB/2.83V/1.0m

Impedance: 4Ω nominal / 2.7Ω min

Response Linearity: 80 - 20kHz +/-1.5dB

Frequency Response (-10dB): bass reflex: 40 - 32kHz; acoustic suspension: 47 - 32kHz

Typical In Room bass extension: bass reflex: 37Hz; acoustic suspension: 43Hz

Dimensions (HxWxD): 546 x 230 x 336mm

Weight: 17.5 kg



Recommended Amplifier Power: 100 - 250W RMS

SPL capability @1m (100-20kHz): 113.2dB peak <3% - 2nd, 3rd Harmonics

Certification: THX Dominus, THX Ultra

R5m High Gloss Black or White
£2,000.00
£2,400.00

Retail Price List - Valid From August 2024

| Reference Series speakers | | | RETAIL ex VAT | RETAIL inc VAT |
|---|--|--|------------------|-------------------|
| <p>MODEL R4b BOOKSHELF</p> <p>Designed to be mounted on optional stand, or wall mounted using dedicated tilt/swivel bracket. Featuring DPC-Array of three 26mm silk domes and single 165mm HFP woofer. THX Ultra certified.</p> <p>Enclosure Alignment: 3-way acoustic suspension Driver complement: DPC-Array: 26mm (3) Silk dome, woofers: 165mm HPF diaphragm Sensitivity: 84.6dB/2.83V/1.0m Impedance: 4Ω nominal / 3.8Ω min Response Linearity: 80 - 20kHz +/-1.5dB Frequency Response (-10dB): 45 - 32kHz Typical In Room bass extension: 38Hz Dimensions (HxWxD): 382 x 230 x 336mm Weight: 9.5 kg Recommended Amplifier Power: 50 - 200W RMS SPL capability @1m (100-20kHz): 107.6dB peak <3% - 2nd, 3rd Harmonics Certification: THX Ultra</p> |  | | | |
| R4b High Gloss Black or White | | | £1,416.67 | £1,700.00 |
| <p>MODEL R4s SURROUND/HEIGHT</p> <p>Designed to be mounted on optional stand, or wall mounted using dedicated tilt/swivel bracket. Featuring DPC-Array of three 26mm silk domes and single 165mm HFP woofer. THX Ultra certified.</p> <p>Enclosure Alignment: 3-way acoustic suspension Driver complement: DPC-Array: 26mm (3) Silk dome, woofers: 165mm HPF diaphragm Sensitivity: 86.5dB/2.83V/1.0m Impedance: 4Ω nominal / 3.7Ω min Response Linearity: 300 - 20kHz +/-1.5dB Frequency Response (-10dB): 48 - 32kHz Typical In Room bass extension: 42Hz Dimensions (HxWxD): 378 x 230 x 173mm Weight: 9.5 kg Recommended Amplifier Power: 50 - 200W RMS SPL capability @1m (100-20kHz): 109.5dB peak <3% - 2nd, 3rd Harmonics Certification: THX Ultra</p> |  | | | |
| R4s High Gloss Black or White | | | £1,250.00 | £1,500.00 |

Retail Price List - Valid From August 2024
Dominus/Ultra certified in-wall speaker
RETAIL
ex VAT

RETAIL
inc VAT

Perlisten R5i-LR
The R5m design adapted for THX Dominus Certified in-wall applications.

Enclosure Alignment: 3-way acoustic suspension

Driver complement: DPC Array: 26mm (3) Silk Dome; Woofers: 165mm (2) HPF

Sensitivity: 89.2dB / 2.83V / 1.0m

Impedance: 4Ω nominal / 3.4Ω min

Response Linearity: 80 - 20kHz +/-1.5dB window

Frequency Response (-10dB): acoustic suspension 39 - 32kHz

Typical In Room bass extension: acoustic suspension 34Hz

Dimensions (HxWxD): 665 x 298 x 111mm

Mounting Dimensions (HxWxD): 624 x 257 x 101.7mm

Weight: 15.9 kg

Recommended Amplifier Power: 50 - 250W RMS

SPL capability @1m (100-20kHz): 113.2dB peak; 111.0dB peak <3% 2nd, 3rd Harmonics

Certification: THX Dominus, THX Ultra

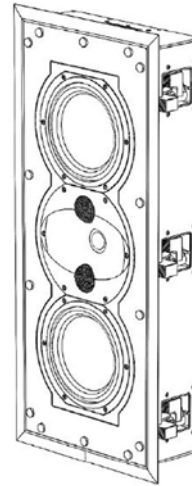
R5i-LR
£2,000.00
£2,400.00
Perlisten R5i-C
The R5c design adapted for THX Dominus Certified in-wall applications.

Enclosure Alignment: 3-way acoustic suspension

Driver complement: DPC Array: 26mm (3) Silk Dome; Woofers: 165mm (2) HPF

Sensitivity: 89.4dB / 2.83V / 1.0m

Impedance: 4Ω nominal / 3.4Ω min

Response Linearity: 80 - 20kHz +/-1.5dB window

Frequency Response (-10dB): acoustic suspension 40 - 32kHz

Typical In Room bass extension: acoustic suspension 34Hz

Dimensions (HxWxD): 298 x 665 x 111mm

Mounting Dimensions (HxWxD): 257 x 624 x 101.7mm

Weight: 15.9 kg

Recommended Amplifier Power: 50 - 250W RMS

SPL capability @1m (100-20kHz): 113.4dB peak; 111.0dB peak <3% 2nd, 3rd Harmonics

Certification: THX Dominus, THX Ultra

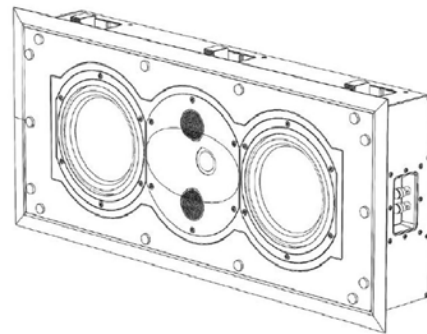
R5i-C
£2,000.00
£2,400.00

Retail Price List - Valid From August 2024

Dominus/Ultra certified in-wall speaker

RETAIL
ex VAT

RETAIL
inc VAT

Perlisten R4i-LCRS

The R4s/R4b designs adapted for THX Dominus Certified in-wall surround channel applications.

Enclosure Alignment: 3-way acoustic suspension

Driver complement: DPC Array: 26mm (3) Silk Dome; Woofers: 165mm (1) HPF

Sensitivity: 88.8dB / 2.83V / 1.0m

Impedance: 4Ω nominal / 3.4Ω min

Response Linearity: 100 - 20kHz +/-1.5dB window

Frequency Response (-10dB): 46 - 37kHz

Typical In Room bass extension: 40Hz

Dimensions (HxWxD): 479 x 298 x 111mm

Mounting Dimensions (HxWxD): 438 x 257 x 101.7mm

Weight: 11.2 kg

Recommended Amplifier Power: 50 – 200W RMS

SPL capability @1m (100-20kHz): 111.8dB peak; 111.0dB peak <3% 2nd, 3rd Harmonics

Certification: THX Dominus Surround, THX Ultra LCR

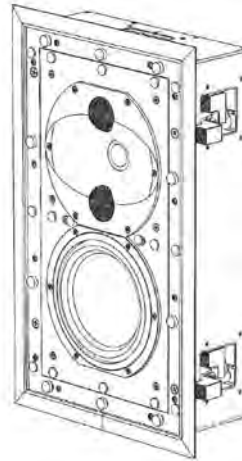

R4i-LCRS

£1,500.00

£1,800.00

On-Wall Adaptor Frames for In-Wall speakers

RETAIL
ex VAT

RETAIL
inc VAT

7i OWF MW on wall frame Matt White for 7 series

£416.67

£500.00

5i OWF MW on wall frame Matt White for 5 series

£333.33

£400.00

4i OWF MW on wall frame Matt White for 4 series

£250.00

£300.00



On-Wall Frame for In-Walls

Retail Price List - Valid From August 2024

Dominus/Ultra certified in-ceiling speakers

RETAIL
ex VAT

RETAIL
inc VAT

R3ic In-Ceiling

A perfect solution for high-end Dolby Atmos, DTS-X and Auro-3D applications and extremely versatile as LCR, surround, height or wide channel speaker.

Enclosure Alignment: 3-way acoustic suspension

Driver complement: DPC Array: 28mm silk dome tweeter; 28mm silk dome mid woofers; 165mm Alum frame, HFP pulp

Sensitivity: 88.8dB / 2.83v / 1.0m; Impedance: 4 Ω nominal / 3.2 Ω min

Listening Window (from 30deg Ref): Horizontal: +/-55 deg;

Vertical: +/-30 deg

Frequency Response: 59 - 30kHz (-6dB); 46 - 33kHz (-10dB)

Typical In Room bass extension: 51Hz (-6dB); 36Hz (-10dB)

Overall Dimensions (with grille) mm: 343.3 dia x 194.8 depth; Recommended cutout: 305mm diameter

Weight: 9.4kg

Certification: THX Dominus, THX Ultra



R3ic in ceiling

£1,500.00

£1,800.00

R2ic In-Ceiling

A great solution for high-end Dolby Atmos, DTS-X and Auro-3D applications, the THX Ultra certified R2ic is a simplified 2-way version of the R3ic.

Enclosure Alignment: 2-way infinite baffle, optional rear enclosure

Driver complement: DPC Array: 28mm Silk Dome; Woofers: 165mm (1) HPF

Sensitivity: 86.0dB / 2.83V / 1.0m; Impedance: 6Ω nominal / 3.4Ω min

Listening Window (from 30deg Ref): Horizontal: +/-55 deg; Vertical: +/-30 deg

Frequency Response (-10dB): 31 - 32kHz

Typical In Room bass extension (-10dB): 22Hz

Dimensions (with grille mm): 343.3 dia x 153.1 depth; Recommended cutout mm: 305 dia

Weight: 5.4kg

Certification: THX Ultra



R2ic in ceiling

£916.67

£1,100.00

Retail Price List - Valid From August 2024
D-Series Subwoofers
RETAIL
ex VAT

RETAIL
inc VAT

MODEL D215s SUBWOOFER

Push-pull driver configuration. Carbon fibre composite diaphragms. Aluminium shorting rings, massive magnets, multi-layer Nomex spiders and lightweight aluminium voice coils. Proprietary 3.0kW amplifier controlled by a 48-bit data bath DSP and 32-bit ARM M4 Cortex processor. All D-Series subs feature a 2.4" LCD touchscreen display and the ability to control advance settings using Perlisten's App. THX Dominus certified.

Alignment: Push-Pull, acoustic suspension

Amplifier: 3.0kW RMS short term

Display Interface: 2.4" LCD colour touchscreen

App: iOS and Android

Processor: 32-bit ARM Cortex M4, double precision floating point math

DSP Engine: Ti DSP 48-bit data paths

Driver complement: (2) 380mm Carbon fibre diaphragm, +/-30mm linear excursion

Reference sensitivity: 92dB / 150mV/ 1.0m

Frequency Response: THX EQ 20-200Hz (-6dB) / 16-210Hz (-10dB); Boost (Large Room) EQ 15-200Hz (-6dB) / 13-210Hz (-10dB); Cut (Small Room) EQ 24-200Hz (-6dB) / 18-210Hz (-10dB)

Inputs: (2) Balanced XLR; (2) Unbalanced RCA

Outputs: (2) Balanced XLR unbuffered; (2) Unbalanced RCA unbuffered

Parametric EQ: 10-Band PEQ with 3 user presets

Low Pass filter: bypass, 30-160Hz, slope 6,12,18,24dB/oct

Phase: variable 0-270°

Polarity: normal / inverted

Configurable Auto turn-on and 12V Trigger: XLR 1, XLR 1+2, RCA 1, RCA 1+2

Dimensions (HxWxD): 805 x 500 x 650.5mm

Weight: 92.0 kg

Certification: THX Dominus

D215s High Gloss Black
£7,666.67
£9,200.00
D215s Matt Black
£7,083.33
£8,500.00

Retail Price List - Valid From August 2024
D-Series Subwoofers
RETAIL
ex VAT

RETAIL
inc VAT

MODEL D212s SUBWOOFER

Push-pull driver configuration. Carbon fibre composite diaphragms. Aluminium shorting rings, massive magnets, multi-layer Nomex spiders and lightweight aluminium voice coils. Proprietary 3.0kW amplifier controlled by a 48-bit data bath DSP and 32-bit ARM M4 Cortex processor. All D-Series subs feature a 2.4" LCD touchscreen display and the ability to control advance settings using Perlisten's App. THX Dominus certified.



Alignment: Push-Pull, acoustic suspension

Amplifier: 3.0kW RMS short term

Display Interface: 2.4" LCD colour touchscreen

App: iOS and Android

Processor: 32-bit ARM Cortex M4, double precision floating point math

DSP Engine: Ti DSP 48-bit data paths

Driver compliment: (2) 300mm, Carbon fibre diaphragm +/-30mm linear excursion

Frequency Response: THX EQ 20-231Hz (-6dB) / 16-245Hz (-10dB); Boost (Large Room) EQ 15-231Hz (-6dB) / 13.5-245Hz (-10dB); Cut (Small Room) EQ 24-231Hz (-6dB) / 18-245Hz (-10dB)

Inputs: (2) Balanced XLR; (2) Unbalanced RCA

Outputs: (2) Balanced XLR unbuffered; (2) Unbalanced RCA unbuffered

Parametric EQ: 10-Band PEQ with 3 user presets

Low Pass filter: Bypass, 30-160Hz, slope 6,12,18,24dB/oct

Phase: Variable 0-270°

Polarity: Normal / inverted

Configurable Auto turn-on and 12V Trigger: XLR 1, XLR 1+2, RCA 1, RCA 1+2

Dimensions (HxWxD): 668 x 420 x 550mm

Weight: 68.0 kg

Certification: THX Dominus

D212s High Gloss Black or White
£5,833.33
£7,000.00

Retail Price List - Valid From August 2024
D-Series Subwoofers
RETAIL
ex VAT

RETAIL
inc VAT

MODEL D15s SUBWOOFER

The D15s is the smallest single THX Dominus certified sub available. Proprietary 2.0kW amplifier controlled by a 48-bit data bath DSP and 32-bit ARM M4 Cortex processor. Carbon fibre composite diaphragms, multiple aluminium shorting rings, massive magnets, multi-layer Nomex spiders and lightweight aluminium voice coils. 2.4" LCD touchscreen display and Perlisten App control.

Alignment: Acoustic suspension

Amplifier: 2.0kW RMS short term

Display Interface: 2.4" LCD colour touchscreen

App: iOS and Android

Processor: 32-bit ARM Cortex M4, double precision floating point math

DSP Engine: Ti DSP 48-bit data paths

Driver compliment: 380mm, Carbon fibre diaphragm +/-30mm linear excursion

Reference sensitivity: 92dB / 150mV/ 1.0m

Frequency Response: THX EQ 20-320Hz (-6dB) / 16-395Hz (-10dB);

Boost (Large Room) EQ 16-320Hz (-6dB) / 14-395Hz (-10dB); Cut (Small Room) EQ 24-320Hz (-6dB) / 18-395Hz (-10dB)

Inputs: (2) Balanced XLR; (2) Unbalanced RCA

Outputs: (2) Balanced XLR unbuffered; (2) Unbalanced RCA unbuffered

Parametric EQ: 10-Band PEQ with 3 user presets

Low Pass filter: Bypass, 30-160Hz, slope 6,12,18,24dB/oct

Phase: Variable 0-270°

Polarity: Normal / inverted

Configurable Auto turn-on and 12V Trigger: XLR 1, XLR 1+2, RCA 1, RCA 1+2

Dimensions (HxWxD): 528 x 500 x 500mm

Weight: 46.0 kg

Certification: THX Dominus

D15s High Gloss Black or White
£4,583.33
£5,500.00

Retail Price List - Valid From August 2024
D-Series Subwoofers
RETAIL
ex VAT

RETAIL
inc VAT

MODEL D12s SUBWOOFER

The smallest subwoofer in the series yet packs enough punch to be certified THX Dominus using a pair of D12s subs. Proprietary 1.5kW amplifier controlled by a 48-bit data bath DSP and 32-bit ARM M4 Cortex processor. Carbon fibre composite diaphragms, multiple aluminium shorting rings, massive magnets, multi-layer Nomex spiders and lightweight aluminium voice coils. 2.4" LCD touchscreen display and Perlisten App control.



Alignment: Acoustic suspension

Amplifier: 1.5kW rms short term

Display Interface: 2.4" LCD colour touchscreen

App: iOS and Android

Processor: 32-bit ARM Cortex M4, double precision floating point math

DSP Engine: Ti DSP 48-bit data paths

Driver complement: 300mm, Carbon fibre diaphragm +/-30mm linear excursion

Reference sensitivity: 92dB / 150mV/ 1.0m

Frequency Response: THX EQ 20-289Hz (-6dB) / 16-330Hz (-10dB);

Boost (Large Room) EQ 16-289Hz (-6dB) / 14-330Hz (-10dB); Cut (Small Room) EQ 25-289Hz (-6dB) / 19-330Hz (-10dB)

Inputs: (2) Balanced XLR; (2) Unbalanced RCA

Outputs: (2) Balanced XLR unbuffered; (2) Unbalanced RCA unbuffered

Parametric EQ: 10-Band PEQ with 3 user presets

Low Pass filter: Bypass, 30-160Hz, slope 6,12,18,24dB/oct

Polarity: Normal / inverted

Configurable Auto turn-on and 12V Trigger: XLR 1, XLR 1+2, RCA 1, RCA 1+2

Dimensions (HxWxD): 448 x 420 x 450mm Weight: 41.0 kg

Certification: THX Dominus (in pairs)

D12s High Gloss Black or White
£3,500.00
£4,200.00

Retail Price List - Valid From August 2024
R-Series Subwoofers
RETAIL
ex VAT

RETAIL
inc VAT

MODEL R212s SUBWOOFER

The R212s is a 2x12" push-pull active subwoofer, powered by a proprietary 1.3kW amplifier. All functions and safeties are controlled by a 48-bit data path DSP and 32-bit ARM M4 Cortex processor. Control is via 2.4" LCD touchscreen display and smartphone app. Certified THX Dominus when two R212s subs are used.

Alignment: Push-Pull, acoustic suspension

Amplifier: 1.3kW rms short term

Display Interface: 2.4" LCD colour touchscreen

App: iOS and Android

Processor: 32-bit ARM Cortex M4, double precision floating point math

DSP Engine: Ti DSP 48-bit data paths

Driver complement: (2)300mm, Glass fibre diaphragm +/-20mm linear excursion

Frequency Response: THX EQ 20-256Hz (-6dB) / 16-278Hz (-10dB); Boost (Large Room) EQ 16-256Hz (-6dB) / 14-278Hz (-10dB); Cut (Small Room) EQ 25-256Hz (-6dB) / 19-278Hz (-10dB)

Inputs: (2) Balanced XLR; (2) Unbalanced RCA

Outputs: (2) Balanced XLR unbuffered; (2) Unbalanced RCA unbuffered

Parametric EQ: 10-Band PEQ with 3 user presets

Low Pass filter: bypass, 30-160Hz, slope 6,12,18,24dB/oct

Phase: Variable 0-270°

Polarity: Normal / inverted

Configurable Auto turn-on and 12v Trigger: XLR 1, XLR 1+2, RCA 1, RCA 1+2

Dimensions (HxWxD): 600 x 410 x 500mm

Weight: 48.2 kg

Certification: THX Dominus (2), THX Ultra (1)

Available finishes: High Gloss Black

R212s High Gloss Black
£4,583.33
£5,500.00

Retail Price List - Valid From August 2024
R-Series Subwoofers
RETAIL
ex VAT

RETAIL
inc VAT

MODEL R210s SUBWOOFER

The R210s is a 2x10" push-pull active subwoofer, powered by a proprietary 1.3kW amplifier. All functions and safeties are controlled by a 48-bit data path DSP and 32-bit ARM M4 Cortex processor. Control is via 2.4" LCD touchscreen display and smartphone app. Certified THX Dominus when four R210s subs are used.

Alignment: Push-Pull, acoustic suspension

Amplifier: 1.3kW rms short term

Display Interface: 2.4" LCD colour touchscreen

App: iOS and Android

Processor: 32-bit ARM Cortex M4, double precision floating point math

DSP Engine: Ti DSP 48-bit data paths

Driver complement: (2)250mm, Glass fibre diaphragm +/-20mm linear excursion

Frequency Response: THX EQ 20-256Hz (-6dB) / 16-278Hz (-10dB); Boost (Large Room) EQ 16-256Hz (-6dB) / 14-302Hz (-10dB); Cut (Small Room) EQ 25-290Hz (-6dB) / 19-302Hz (-10dB)

Inputs: (2) Balanced XLR; (2) Unbalanced RCA

Outputs: (2) Balanced XLR unbuffered; (2) Unbalanced RCA unbuffered

Parametric EQ: 10-Band PEQ with 3 user presets

Low Pass filter: bypass, 30-160Hz, slope 6,12,18,24dB/oct

Phase: Variable 0-270°

Polarity: Normal / inverted

Configurable Auto turn-on and 12v Trigger: XLR 1, XLR 1+2, RCA 1, RCA 1+2

Dimensions (HxWxD): 545 x 380 x 450mm

Weight: 44.0 kg

Certification: THX Dominus (4), THX Ultra (1)

Available finishes: High Gloss Black

R210s High Gloss Black
£3,666.67
£4,400.00

Retail Price List - Valid From August 2024

R-Series lineup of single driver based subwoofers use trickle down technology from the flagship D-Series models with new proprietary drivers featuring glass fibre composite diaphragms, massive magnets, and lightweight aluminium voice coils powered by a new 1.0kW amplifier. Control is via a 48-bit data bath DSP and 32-bit ARM M4 Cortex processor, able to react in microseconds ensuring sonic accuracy. All R-Series subs share Perlisten's 2.4" LCD touchscreen display and ability to control advance settings using its App.

R-Series Subwoofers
RETAIL
ex VAT

RETAIL
inc VAT

MODEL R18s

Alignment: Acoustic suspension

Amplifier: 1.0kW rms

Display Interface: 2.4" LCD colour touchscreen

App: iOS and Android

Processor: 32-bit ARM Cortex M4, double precision floating point math

DSP Engine: Ti DSP 48-bit data paths

Driver complement: 460mm, Glass fibre diaphragm +/-23.7mm linear excursion

Reference sensitivity: 95dB /150mV/ 1.0m

Frequency Response: THX EQ 20-288Hz (-6dB) / 16-340Hz (-10dB);

Boost (Large Room) EQ 16-288Hz (-6dB) / 14-340Hz (-10dB); Cut (Small Room) EQ 25-288Hz (-6dB) / 19-340Hz (-10dB)

Inputs: (1) Balanced XLR; (1) Unbalanced RCA

Outputs: (1) Balanced XLR unbuffered; (1) Unbalanced RCA unbuffered

Parametric EQ: 10-Band PEQ with 3 user presets

Low Pass filter: Bypass, 30-160Hz, slope 6,12,18,24dB/oct

Phase: Variable 0-270°

Polarity: Normal / inverted

Configurable Auto turn-on and 12v Trigger: XLR, RCA

Dimensions (HxWxD): 618 x 570 x 575mm

Weight: 57.3 kg

Available finishes: Matt Black

MODEL R18s Matt Black
£4,166.67
£5,000.00

Retail Price List - Valid From August 2024
R-Series Subwoofers
RETAIL
ex VAT

RETAIL
inc VAT

MODEL R15s

Alignment: Acoustic suspension
 Amplifier: 1.0kW rms
 Display Interface: 2.4" LCD colour touchscreen
 App: iOS and Android
 Processor: 32-bit ARM Cortex M4, double precision floating point math
 DSP Engine: Ti DSP 48-bit data paths
 Driver complement: 380mm, Glass fibre diaphragm +/-23.7mm linear excursion
 Reference sensitivity: 92dB /150mV/ 1.0m
 Frequency Response: THX EQ 20-388Hz (-6dB) / 16-468Hz (-10dB);
 Boost (Large Room) EQ 16-388Hz (-6dB) / 14-468Hz (-10dB); Cut (Small Room) EQ 25-388Hz (-6dB) / 19-468Hz (-10dB)
 Inputs: (1) Balanced XLR; (1) Unbalanced RCA
 Outputs: (1) Balanced XLR unbuffered; (1) Unbalanced RCA unbuffered
 Parametric EQ: 10-Band PEQ with 3 user presets
 Low Pass filter: Bypass, 30-160Hz, slope 6,12,18,24dB/oct
 Phase: Variable 0-270°
 Polarity: Normal / inverted
 Configurable Auto turn-on and 12v Trigger: XLR, RCA
 Dimensions (HxWxD): 498 x 460 x 465mm
 Weight: 35.5 kg
 Available finishes: Matt Black

MODEL R15s Matt Black
£3,333.33
£4,000.00

Retail Price List - Valid From August 2024
R-Series Subwoofers
RETAIL
ex VAT

RETAIL
inc VAT

MODEL R12s

Alignment: Acoustic suspension
 Amplifier: 1.0kW rms
 Display Interface: 2.4" LCD colour touchscreen
 App: iOS and Android
 Processor: 32-bit ARM Cortex M4, double precision floating point math
 DSP Engine: Ti DSP 48-bit data paths
 Driver complement: 300mm, Glass fibre diaphragm +/-23.7mm linear excursion
 Reference sensitivity: 90dB /150mV/ 1.0m
 Frequency Response: THX EQ 20-296Hz (-6dB) / 16-380Hz (-10dB);
 Boost (Large Room) EQ 16-296Hz (-6dB) / 14-380Hz (-10dB); Cut (Small Room) EQ 25-296Hz (-6dB) / 19-380Hz (-10dB)
 Inputs: (1) Balanced XLR; (1) Unbalanced RCA
 Outputs: (1) Balanced XLR unbuffered; (1) Unbalanced RCA unbuffered
 Parametric EQ: 10-Band PEQ with 3 user presets
 Low Pass filter: Bypass, 30-160Hz, slope 6,12,18,24dB/oct
 Phase: Variable 0-270°
 Polarity: Normal / inverted
 Configurable Auto turn-on and 12v Trigger: XLR, RCA
 Dimensions (HxWxD): 428 x 390 x 375mm
 Weight: 26.7 kg
 Available finishes: Matt Black

MODEL R12s Matt Black
£2,500.00
£3,000.00

Retail Price List - Valid From August 2024
R-Series Subwoofers
RETAIL
ex VAT

RETAIL
inc VAT

MODEL R10s

Alignment: Acoustic suspension
 Amplifier: 750W rms
 Display Interface: 2.4" LCD colour touchscreen
 App: iOS and Android
 Processor: 32-bit ARM Cortex M4, double precision floating point math
 DSP Engine: Ti DSP 48-bit data paths
 Driver complement: 250mm, Glass fibre diaphragm +/-20.0mm linear excursion
 Reference sensitivity: 88dB /150mV/ 1.0m
 Frequency Response: THX EQ 20-301Hz (-6dB) / 16-380Hz (-10dB);
 Boost (Large Room) EQ 16-301Hz (-6dB) / 14-380Hz (-10dB); Cut (Small Room) EQ 25-301Hz (-6dB) / 19-380Hz (-10dB)
 Inputs: (1) Balanced XLR; (1) Unbalanced RCA
 Outputs: (1) Balanced XLR unbuffered; (1) Unbalanced RCA unbuffered
 Parametric EQ: 10-Band PEQ with 3 user presets
 Low Pass filter: Bypass, 30-160Hz, slope 6,12,18,24dB/oct
 Phase: Variable 0-270°
 Polarity: Normal / inverted
 Configurable Auto turn-on and 12v Trigger: XLR, RCA
 Dimensions (HxWxD): 388 x 340 x 380mm
 Weight: 21.0 kg
 Available finishes: Matt Black

MODEL R10s Matt Black
£1,833.33
£2,200.00

Retail Price List - Valid From August 2024

| Accessories | | | | RETAIL ex VAT | RETAIL inc VAT |
|--------------|------------------------------------|--|--|------------------|-------------------|
| SSLR-HGB | S Series stand L/R pair | | | £1,250.00 | £1,500.00 |
| SSC-HGB | S Series Centre stand | | | £625.00 | £750.00 |
| RSLR-HGB | R Series Stand L/R pair | | | £1,125.00 | £1,350.00 |
| RSC-HGB | R Series Centre stand | | | £541.67 | £650.00 |
| R/S-BRCKT | S/R Series wall bracket up to 25kg | | | £50.00 | £60.00 |
| Grille D215s | | | | £158.33 | £190.00 |
| Grille D212s | | | | £141.67 | £170.00 |
| Grille D15s | | | | £100.00 | £120.00 |
| Grille D12s | | | | £95.83 | £115.00 |
| Grille R212s | | | | £133.33 | £160.00 |
| Grille R210s | | | | £125.00 | £150.00 |
| Grille R18s | | | | £116.67 | £140.00 |
| Grille R15s | | | | £100.00 | £120.00 |
| Grille R12s | | | | £95.83 | £115.00 |
| Grille R10s | | | | £87.50 | £105.00 |
| Grille R-Ser | R Series round grille | | | £45.83 | £55.00 |
| PCK-7i | Pre Install Kit | | | £125.00 | £150.00 |
| PCK -5i | Pre Install Kit | | | £125.00 | £150.00 |
| PCK- 4i | Pre Install Kit | | | £125.00 | £150.00 |
| PCK- 3ic | Pre Install Kit | | | £125.00 | £150.00 |